







VELVET FRAME SCREEN (VFS)

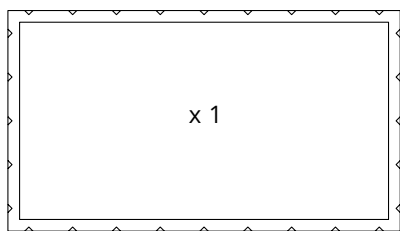

OPERATION GUIDE/BRUKSANVISNING/GEBRAUCHSANWEISUNG/GEbruiksaanwijzing/KÄYTTÖOHJEET

MOUNTING BATCH / MONTERINGSSATS / MONTAGEPAKET / MONTAGE MATERIAAL / ASENNUSSARJA

 x 4
  x 2
  x 16
  x 16



	VFS210	VFS240	VFS270	VFS300	VFS400
	16:9 x22	16:10 x22	16:9 x26	16:10 x32	16:9 x34
	16:10 x22	16:9 x26	16:10 x30	16:9 x34	16:9 x42

 x 2
  x 2

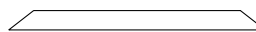
 x 2



 x 2

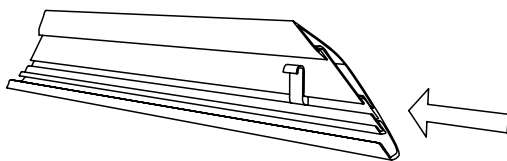

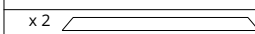
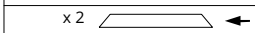
1:7

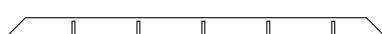

	VFS210	VFS240	VFS270	VFS300	VFS400
 x 2	16:9 x7	16:10 x7	16:9 x8	16:10 x9	16:9 x13
 x 2	16:9 x4	16:10 x5	16:9 x5	16:10 x6	16:9 x8

2:7

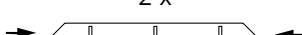
 x 2
  x 2

 x 2
  x 2

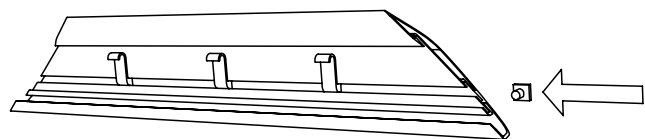

3:7

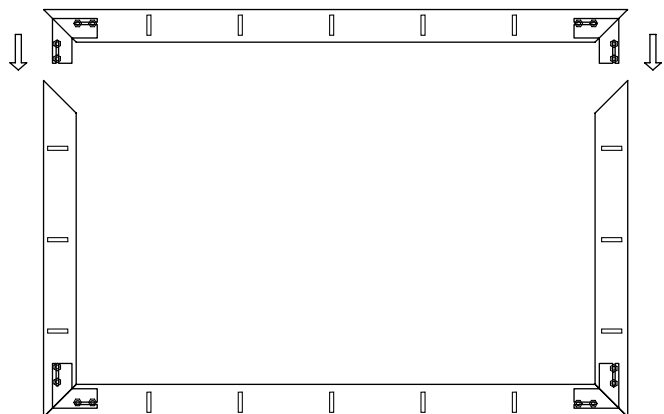
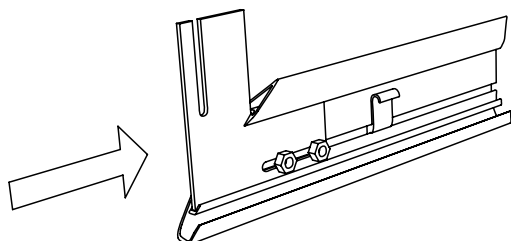

4:7

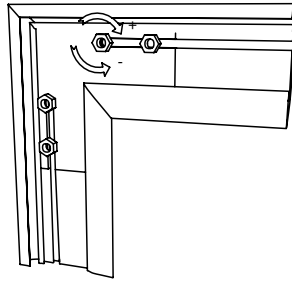

5:7

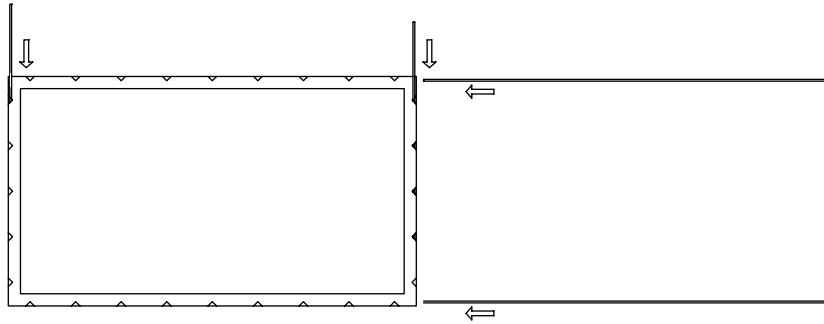

6:7



7:7

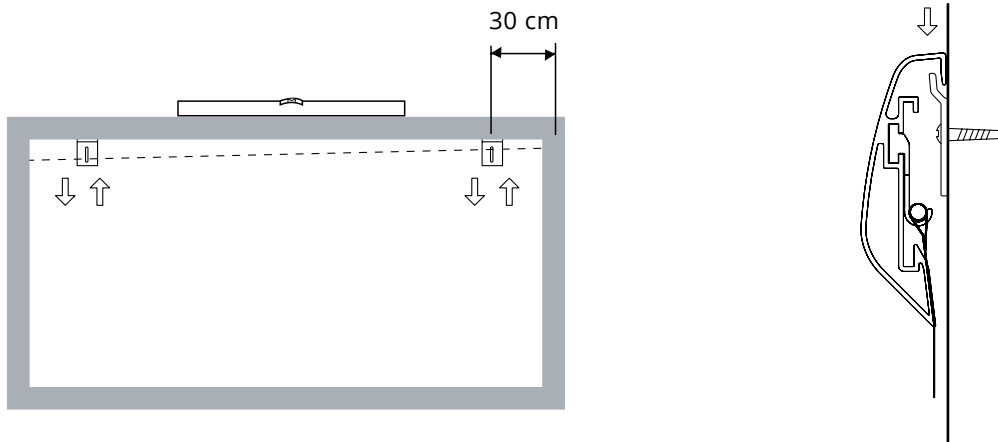

FOR SERVICE/HUOLTO:

All Countries www.kingpinscreens.com

NORWAY www.avpartner.no